

Standard enclosure
Series CT (ABS)

Designation CT-872 T ABS **Article number 387100000**

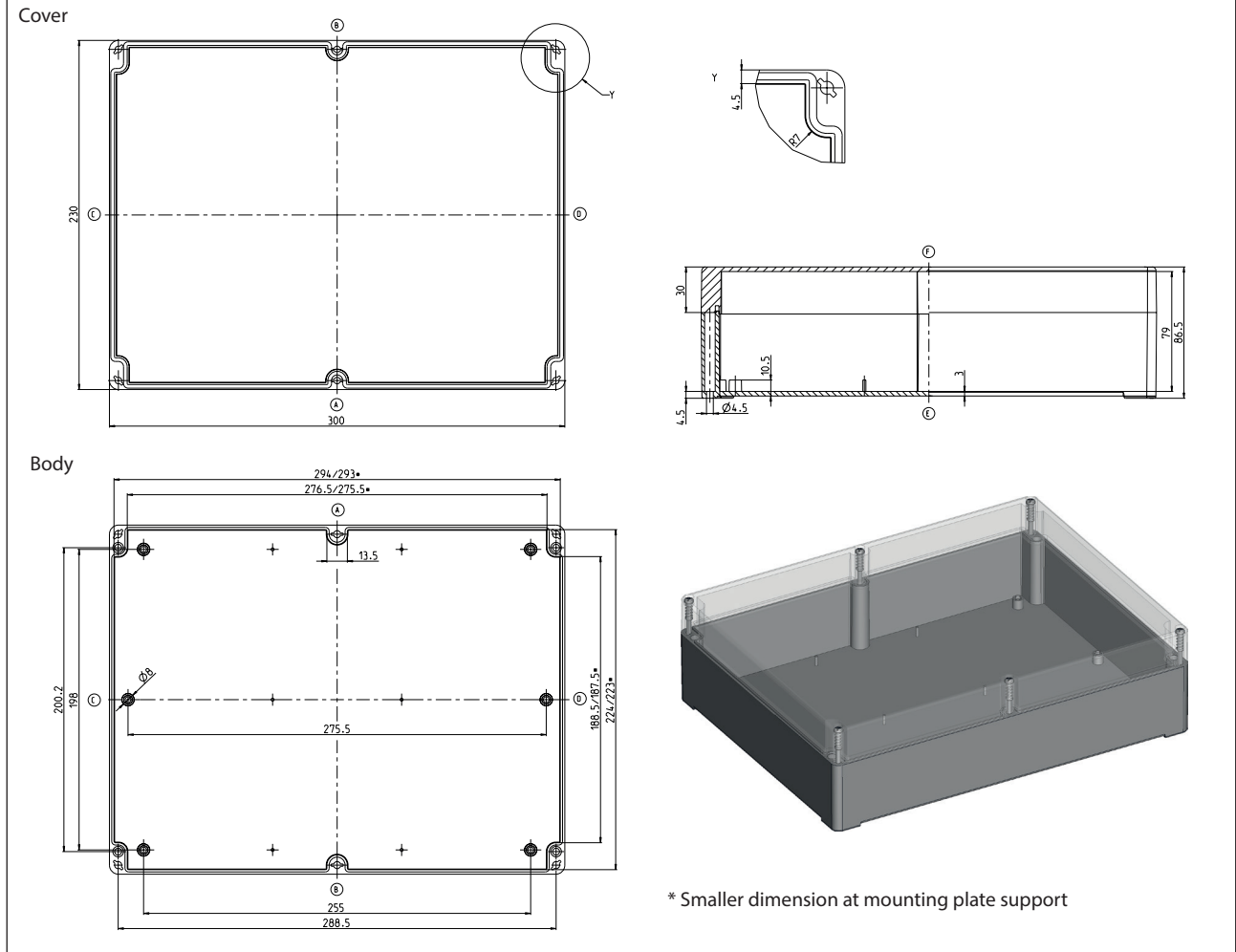

Standard version

Scope of supply:

- Base of enclosure
- Enclosure cover
- Quick-release screw (cross recessed head) enclosed loosely
- Colour RAL 7035 (light grey)
- Cover gasket PUR (polyurethane)
- Internal mounting plugs for selftapping screws (are included)
- Individually packaged in foil

Maximum possible number of thread (figures for identical diameter, not mixed!)

ISO M	M12	M16	M20	M25	M32	M40	M50	M63
Page A/B	34	14	10	6	4	0	0	0
Page C/D	21	13	5	4	2	0	0	0

Property chart CT-872 T

Specification	Value	According to the standard	Remark
General data:			
Weight	850 g		
External dimensions	300 x 230 x 86		
Protection classes			
IP code	IP 66	EN 60529	
IK code	IK 07	IEC 62262	
Material			
Enclosure			
Body	ABS		light grey
Cover	Polycarbonat (PC)		transparent
Quick-release fastener	1.4303		DIN EN 10088-3
Screws	A2 - 70		DIN EN ISO 3506-1
Seal	PUR (Polyurethan)		Colour: dark grey, 2-component polyurethane foam seal
Toxic behaviour	halogen-free		
Thermal properties:			
Fire behaviour			
Flammability	HB	UL 94	Contentwise alike with EC60695-11-10 and IEC60695-11-20
Flame class:	1,2 mm HB 75	IEC 60695-11-10	
Flame class:	1,5 mm HB 75	IEC 60695-11-10	
Flame class:	3 mm HB 40	IEC 60695-11-10	
Temperature range			
Enclosure without a seal	-40 °C bis +120 °C		
Seal PUR	-40 °C bis +100 °C		
Temperature index Enclosure material			
RTI (tensile strength)	60 °C	UL 746 B	
RTI (impact strength)	60 °C	UL 746 B	
RTI (dielectric strength)	60 °C	UL 746 B	
Ambient temperatur according to DIN EN 62208			
Indoor application	-5 °C bis +40 °C	DIN EN 62208	On the average over 24h +35°C
Relative humidity according to DIN EN 62208			
Indoor application	max. 50% bei -40 °C	DIN EN 62208	with low temperatures also higher (for ex. 90% at +20°C)
Storage temperature	-20 °C bis +60 °C		
Enclosure-specific thermal conductivity value	1,54 K/W		taking account of effective dissipation loss

Property chart CT-872 T

Specification	Value	According to the standard	Remark
Mechanical properties:			
Torques			
quick – release screw	1/4 Rotation		
Attachment of accessories	1,0 Nm		for ex. mounting plates, mounting rails
Other mounting	1,0 Nm		Screw channel, External mounting brackets
Maximum installation weight	3,4 kg		
Electrical characteristics:			
Protection class	II	EN 61140 / VDE 0140-1	 Protection by double or reinforced insulation
Rated voltage	max. 1000V		Maximum length of the extension arm
Surface resistivity	10 ¹⁶ Ohm	IEC 60093	
Dielectric strength	23 kv/mm	IEC 60243-1	short-term
More details:			
General tolerance	mH	ISO 2768	
Product standard	Yes	DIN EN 62208	Empty enclosures for low-voltage switchgear assemblies
Approvals			
c UL us	No		
Compliances			
RoHs	Yes	Directive 2011/65/EU	
CE label	Yes	EC-No 765/2008	
Low-Voltage-Directive No.:	2014/35/EU		

Other versions / Accessories

The following information is not a standard. Approvals, compliances and protection classes of these versions upon request.

Other version CT-872 T	
Description of the modification compared with the standard version	Article number
ABS, with transparent cover (PC) and screw fastener	on request

Possible Accessories / as individual parts or as assembly set	
Description of the modification compared with the standard version	Article number
Mounting plate	9512019000
Mounting rail TS 15	-
Mounting rail TS 32	9821010000
Mounting rail TS 35	9822013000
Earthing rail (secured on central bosses C/D)	9810012000
External mounting brackets	9802002000
External articulated hinges (mechanical machining of the enclosure required)	9802025000
Internal articulated hinges (flexible)	9801079000
Mounting bushes with 4 screws M3 x 8	9800025000

Optional seals			
Specification	Value	According to the standard	Remark
Thermal properties:			
CR seal	-30 °C bis +80 °C		IP65
Silicone foam seal	-60 °C bis +130 °C		on request
Silicone complete seal	-60 °C bis +200 °C		on request
EPDM seal	-35 °C bis +100 °C		on request
HF seal	-55 °C bis +125 °C		on request